



# geosky

formwork system for slabs



- VERSATILE
- EASY TO HANDLE
- REUSABLE

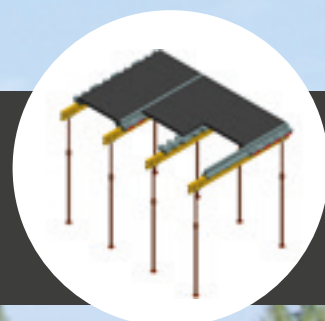



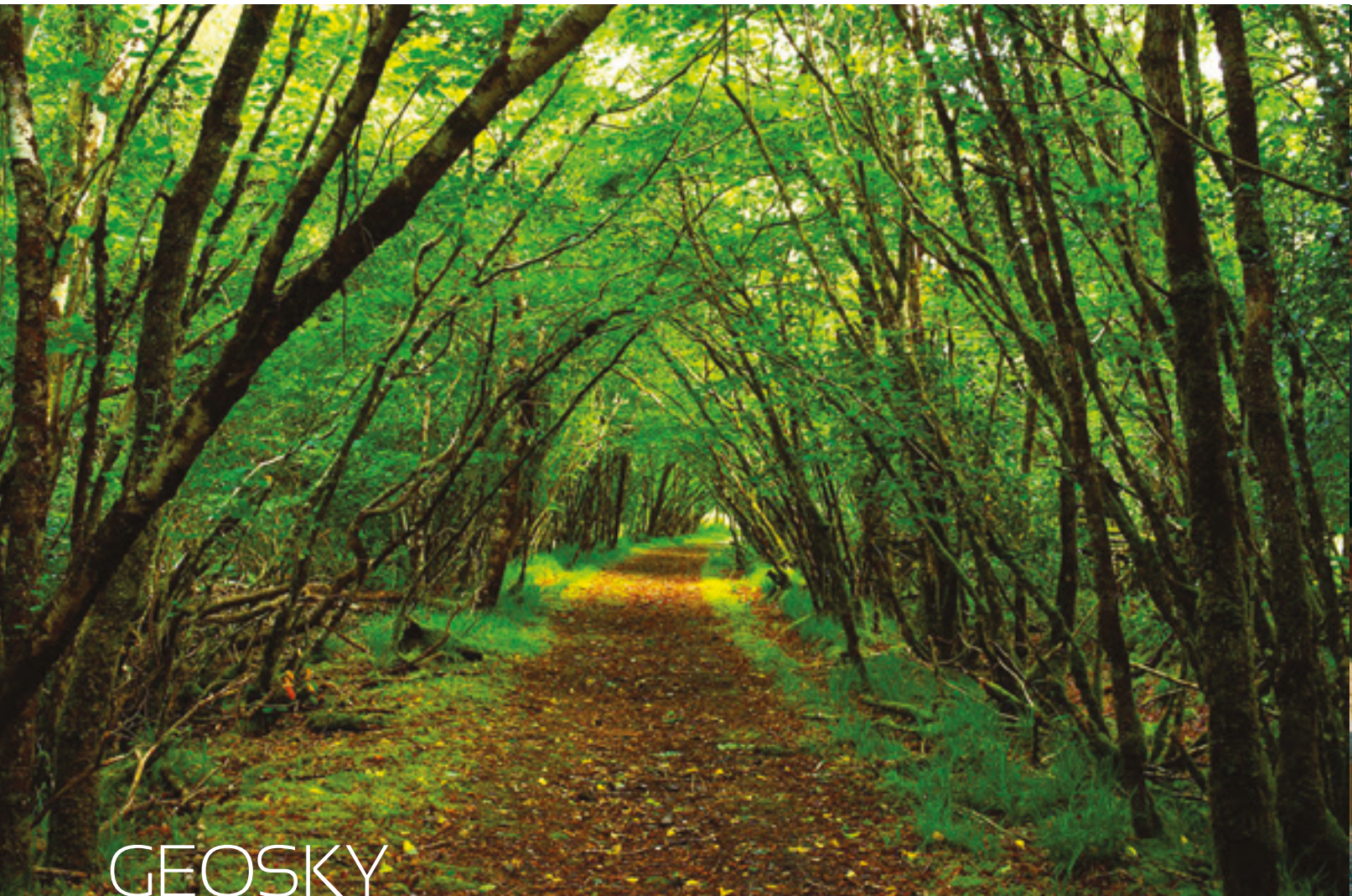

# GEOSKY VISION

**BUILD and RESPECT:** this is the vision which distinguishes Geoplast's products. Construct buildings and respect the environment. From the choice of the raw materials. Our plastic formwork embody this principle.

**THE WOOD ANNUAL CONSUMPTION IS EQUAL TO 1,5 BILION M<sup>3</sup> PER YEAR, OF WHICH THE 55% IS USED IN BUILDINGS.**

After having exhausted the wood sources in South-East Asia and in Central Africa, deforestation expanded in the Amazonian rainforest, which is the "green lung" of our planet.

During the last 3 decades, about 55 hectares of rainforest were cleared in this area. A surface which is equal to France.

To face this problem, we decided to create a plastic formwork. A recyclable material, that is the only available alternative to wood and cardboard.

We obtained it with a special focus on its lightness, in order to reduce the needed consumption of energy that is required to move it: even this is a form of respect.

Geoplast S.p.A. in Green Building Council Italy,  
The Network for Eco-friendly building.







# GEOSKY TECHNOPOLYMER FORMWORK

**GEOSKY** is the first formwork made of technopolymer for the creation of flat decks; a complete system for the realization of solid ceilings or lightened slabs, unidirectional or biaxial.

**GEOPANEL** formwork, that is **GEOSKY** main element, is the only system that allows the creation of both flat decks and walls.

Light and modular, **GEOSKY** is the new idea of a reusable formwork, easy to storage and easy to clean with a little water. Ideal with renovation work.



## Why ABS (Acrylonitrile Butadiene Styrene)

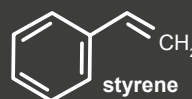
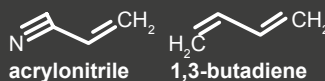

- High mechanical resistance •
- Shock absorption capability •
- High temperature stability •  
(-30°C / + 70°C)
- High product surface quality •
- Recyclable material •



# SLABS FORMWORK



## Geopanel invents the Slab

**GEOSKY**, is a reusable formwork system made of plastic for the creation of flat decks to place the slabs. Its innovative system allows, thanks to the main beam with a sliding wedge, a quick installation and disarming. Moreover, it is also possible to reduce the rotation of the formwork material in the

construction site, in order to accelerate the pouring stages. The system consists of **GEOPANEL** panels 120x60 cm (with maximum weight of 11 kg) and 3 plastic beams that should adequately be placed on the H20 wood traditional trusses that allow the early stripping of the formwork system.





# GEOSKY SYSTEM ADVANTAGES



Reusable formwork system for the creation of flat decks to place slabs



## early stripping

The concrete does not stick to plastic, allowing an easy dismantling and a fast cleaning, without the use of any particular detergent, just a little water



## modularity

**GEOPANEL** is the only commercially available panel, that allows the creation of flat decks for walls



## no releasing agents

**GEOSKY** consists of ABS elements which does not require releasing agents



## lightness

Weighting only 11 kg **GEOPANEL** can be quickly handled in the construction site, without the use of cranes or mechanical lifting devices



## reuse

**GEOSKY** is a cost-effective system as it can be used more than 100 times with an appropriate cleaning and use



## storage

**GEOSKY** can be completely dismantled and stored in damp locations

# EARLY DISMANTLING



## The dismantling

**GEOSKY** system, thanks to its accessories, allows the early dismantling of the slab. The early dismantling consists in the removal of a large part of the elements that are included in the system before reaching 28 days of concrete complete

consolidation. This operation is facilitated by the Y-BEAM system + WEDGE that allows the removal of the **GEOPANEL** panels keeping the slab shored and avoiding deformations.

## ADVANTAGES

PANELS OPTIMIZATION  
QUICK DISMANTLING  
WORKSITE  
ECONOMISATION





# GEOPANEL SLAB WALL

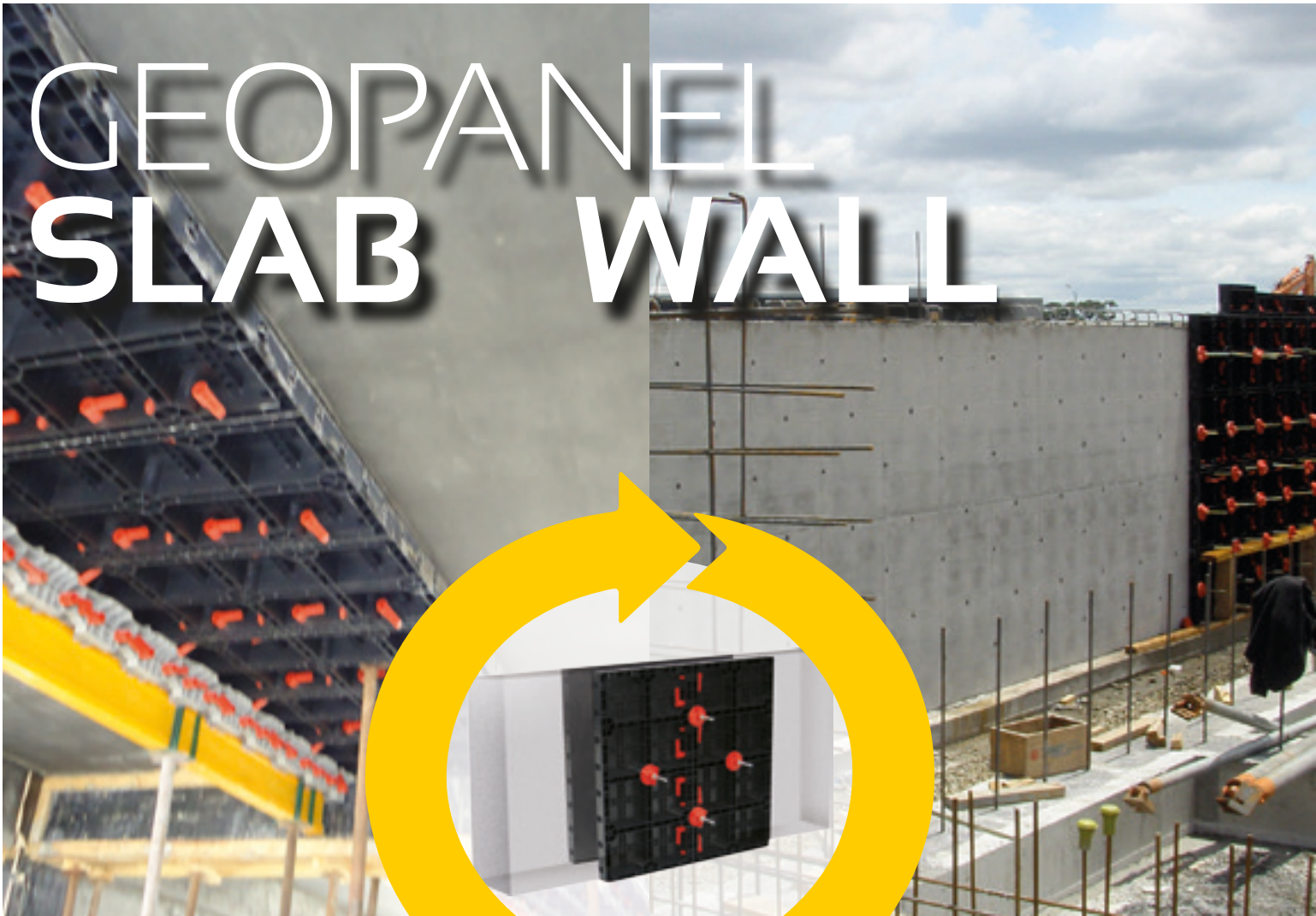

## Versatile in the worksite

**GEOPANEL** panel that is included in the **GEOSKY** system is the only panel that allows the creation of both walls and slabs. As it is made of ABS, it is very resistant (reusable for more than 100 times) and lightweight. It guarantees the

handling without any mechanical lifting mean. With a single system it is possible to carry out more than one operation, vertical and horizontal structure, of the same worksite.



# EARLY REMOVAL

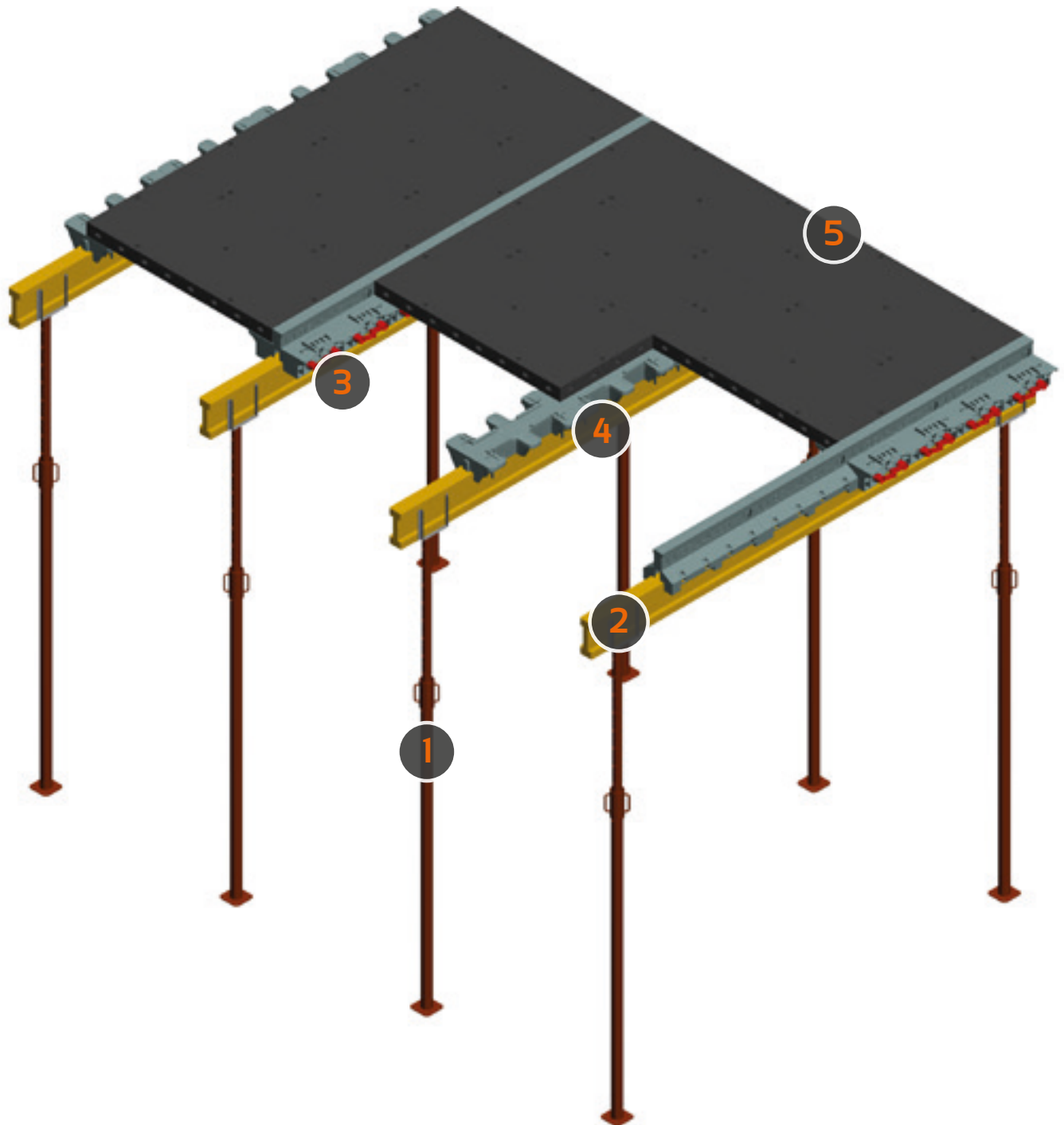

1 PROP

3 Y BEAM + WEDGE

5 **GEOPANEL**

2 WOODEN BEAM

4 H BEAM



# Y BEAM & WEDGE

The WEDGE allows an early removal of the formwork.

The WEDGE is hooked to the Y BEAM through GEOPLAST universal handles, creating a flat deck for GEOPANEL. Once the pouring is completed, it is possible to release the handles and remove the WEDGE, in order to reuse GEOPANEL.

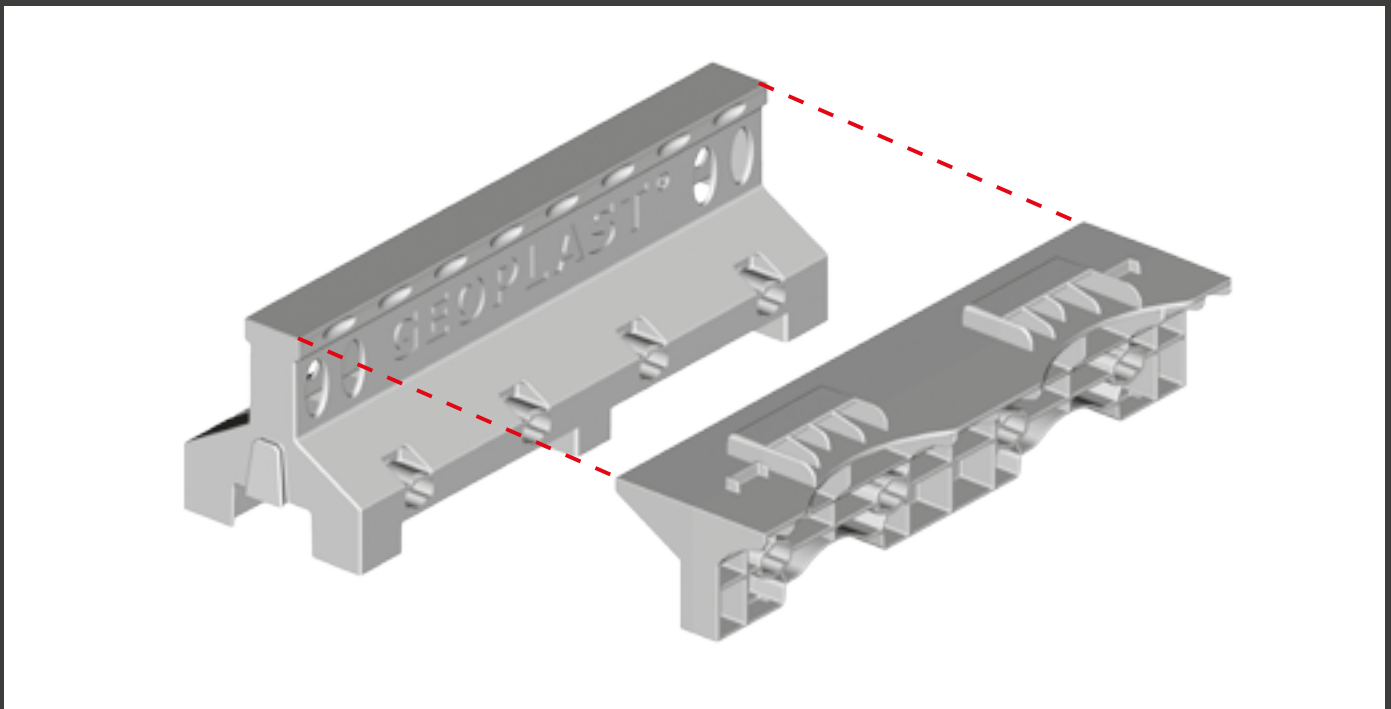

## GEOSKY components

Y BEAM  
 WEDGE  
 HANDLE  
 H BEAM

19.1 x 60.5 x 20 cm  
 16 x 60.5 x 11.8 cm  
 universal  
 H 31 x 60.5 x 12.1 cm

The H BEAM integrates the accessories. It functions as a crossbar. The elements of GEOPANEL are simply placed on it. During the re-

moval stage the first element is removed with the reinforcement beam.





# A SOLUTION TO THE RIGID FORMWORK

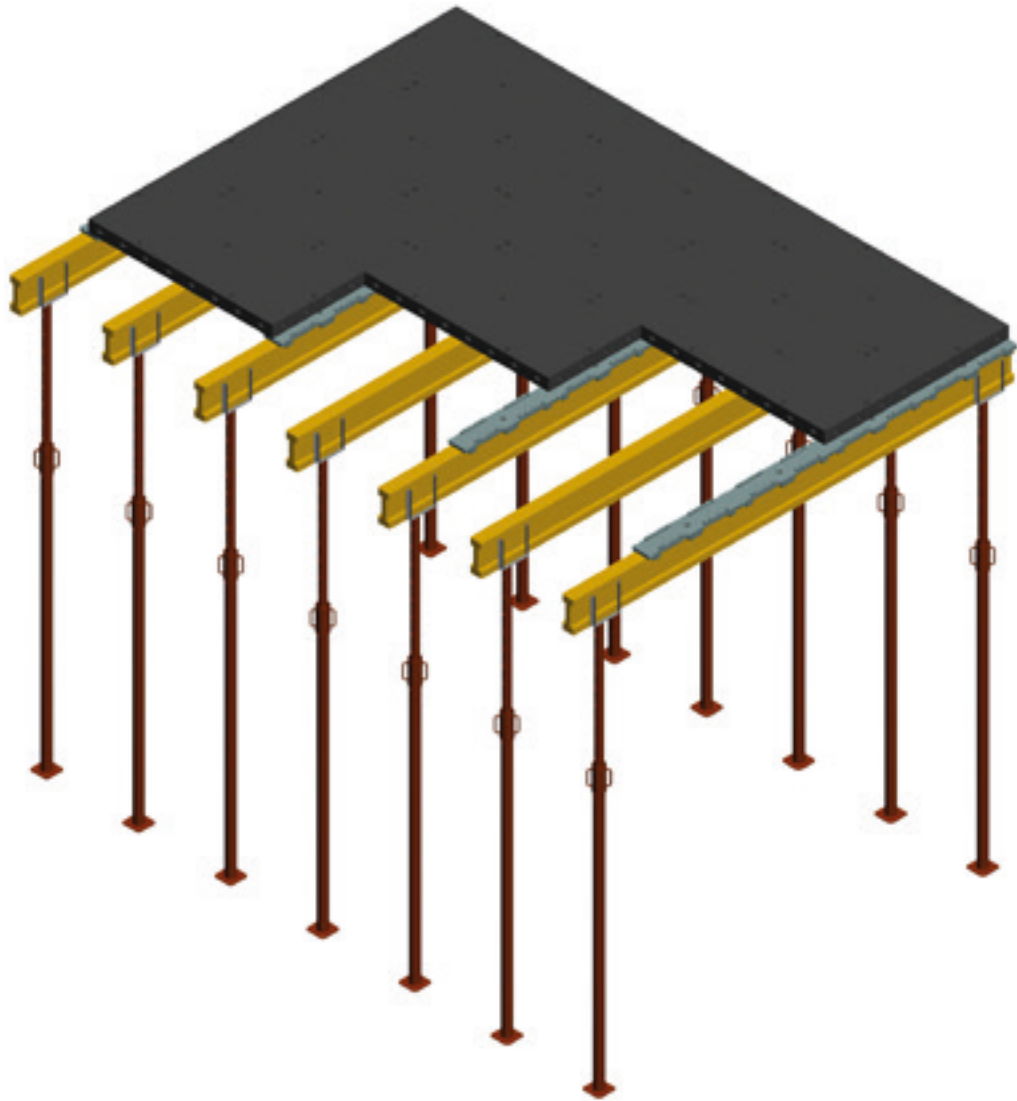

- ① CROP
- ③ Y BEAM + WEDGE
- ⑤ **GEOPANEL**

- ② WOODEN BEAM
- ④ H BEAM



# BEAM HS

HS beam is an alternative to the typical beams we described before (Y, H e WEDGE).

This element allows the maximal reduction of the plastic thickness and it is possible to have just one element for GEO-PANEL installation. The HS BEAM does not allow the early removal of the formwork, that is the formwork has to remain operational until the 28<sup>th</sup> day after the concrete pouring.

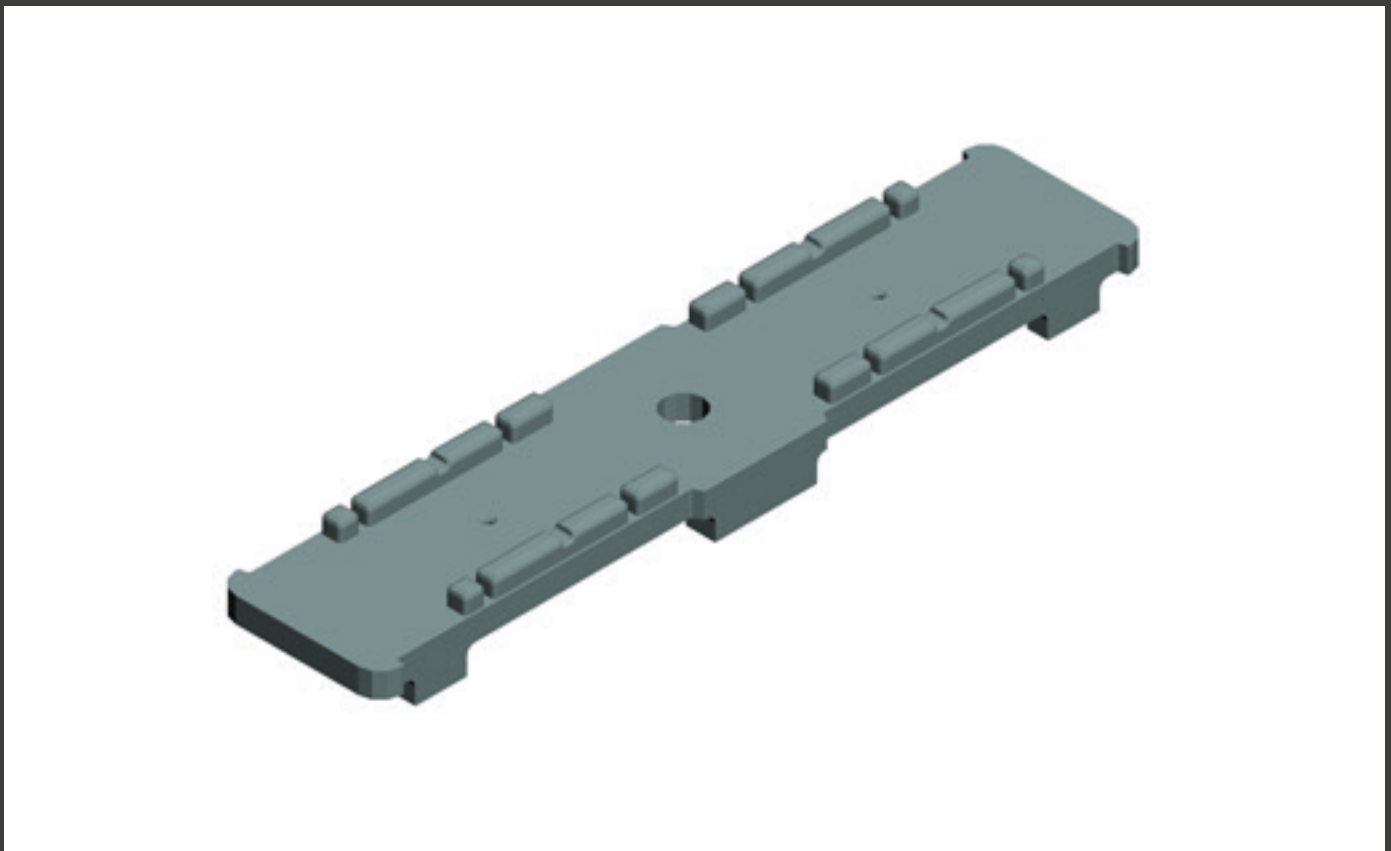

**GEOSKY** components

BEAM HS - 13x60.5x5.8 cm





Elements and accessories

# DIMENSIONAL TABLES



**BEAM  
Y**

19.1x 60.5 x H20

ABS

2.83

100x 121x H216

140

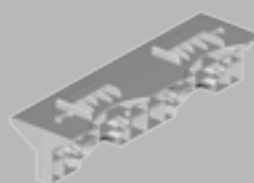

**WEDGE**

16 x 60.5 x 11.8

ABS

1.81

75 x 120 x H190

204



**BEAM  
H**

31x 60.5 x 12.1

ABS

2.83

120 x 124 x H196

120

real size (cm)  
material  
weight (kg)  
packaging size (cm)  
no. pcs. per pallet

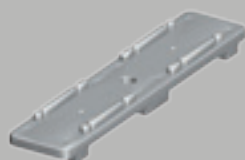

**BEAM  
HS**

13x 60.5 x 5.8

ABS

0.68

75 x 121x H228

594

real size (cm)  
material  
weight (kg)  
packaging size (cm)  
no. pcs. per pallet



**BEA  
WP**

61x 60.5 x 8

ABS

6.28

75 x 120 x H255

76

4



**HANDLE**

NYLON

0.1

200 (bag)

5000



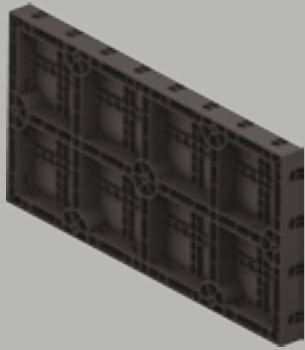

**GEOPANEL**  
**120 x 60**

121 x 60.5 x 8

ABS

11

75 x 121 x H258

38

12



**GEOPANEL**  
**20 x 60 x 8**

20.2 x 60.5 x 8

ABS

2.38

77 x 121 x H235

204

5



**GEOPANEL**  
**25 x 60 x 8**

25.2 x 60.5 x 8

ABS

2.62

77 x 121 x H240

166

5



**GEOPANEL**  
**30 x 60 x 8**

30.3 x 60.5 x 8

ABS

2.94

77 x 121 x H240

140

5

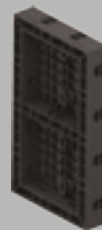

**GEOPANEL**  
**35 x 60 x 8**

35.3 x 60.5 x 8

ABS

3.36

75 x 121 x H235

118

6



**GEOPANEL**  
**40 x 60 x 8**

40.4 x 60.5 x 8

ABS

3.70

77 x 121 x H240

104

6

real size (cm)  
 material  
 weight (kg)  
 packaging size (cm)  
 no. pcs. per pallet  
 no. handles

real size (cm)  
 material  
 weight (kg)  
 packaging size (cm)  
 no. pcs. per pallet  
 no. handles

# LOW BEAMS PLASTIC-WOOD

FOCUS  
GEOPANEL  
WP

## Nonstandard thickness beams

The creation of low beams has now become easier with **GEOPANEL WP**. **GEOPANEL WP** simplifies the operations in close proximity to low beams in the worksite. In fact, it is sufficient to place the wooden panels on the WP shelves to create both

the compensation and the attach for the low beam. This system is compatible with both the slab solutions **GEOPLAST** suggested before. It can be used with early removal systems and with rigid systems

WP **GEOPANEL** is a small size panel used for wooden compensations. The wooden compensation panel is placed on **GEOPANEL WP** and fixed to it through the wood self-tapping

screws. **GEOPANEL WP** is available in 3 versions WP27, WP21 and WP18 on the basis of the thickness of the used wooden beams.





# WALL COMPENSATION



## Simplify the compensations

GEOSKY system is provided with a series of **GEOPANEL** panels which allow the creation of any size compensations. If **GEOPANEL** is not sufficient, it is possible to use the WP accessory, in or-

der to create a base where the wooden panels will be placed. The wooden panels are simply fixed to the WP with self-tapping screws.

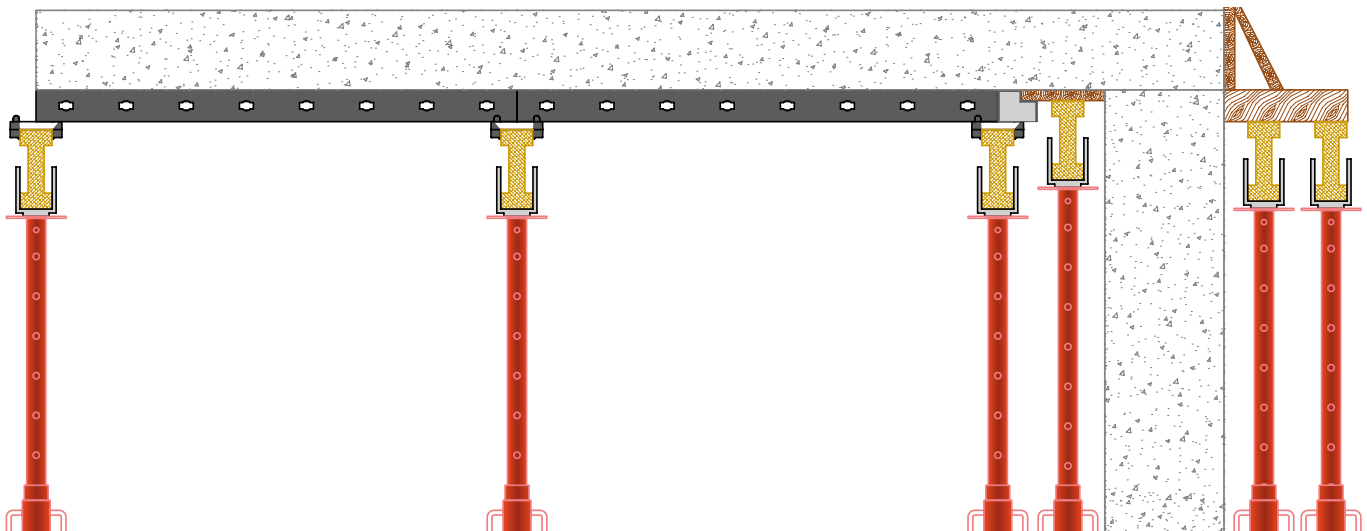

# MODULARITY IN THE WORKSITE

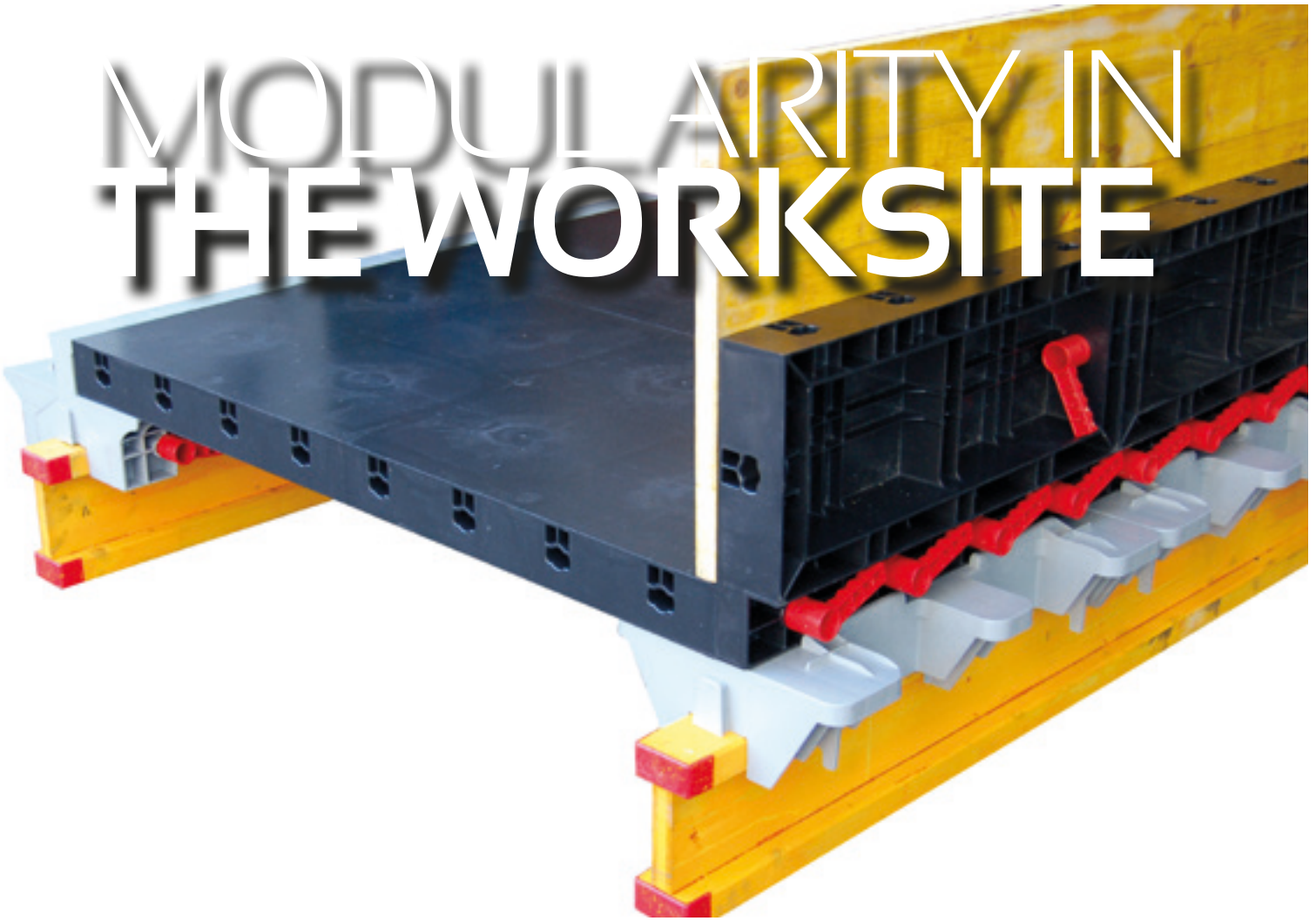

## Side closures

**GEOSKY** is adaptable to any worksite situation. Sometimes there is the need to create crawl spaces for the pipes transit, stairway voids or side closures of the pour. This operation is easier with

**GEOSKY**, it is sufficient to fix the wooden stopends to the **GEOPANEL** panel's holes through rolling bars.









# INSTALLATION PROCESS

## FORMWORK INSTALLATION



① PLACE OF THE Y BEAMS + WEDGE



② PLACE OF THE H BEAMS



③ PLACE OF THE GEO-PANEL PANELS

## ARMIERUNG AND POUR



④ ADD THE REIN-FORCEMENT



⑤ CONCRETE POUR



⑥ CONCRETE LEVEL-LING

## EARLY REMOVAL



⑦ REMOVAL OF H BEAM



⑧ WEDGE REMOVAL



⑨ REMOVAL OF THE GEO-PANEL PANELS

## Geoplast Technical Assistance

Geoplast Technical Unit and its staff of structure engineers, guarantees the required support during all the stages in the worksite. After having analyzed the technical specifications and any possible restriction, the technical unit defines the most suitable formwork system configuration and develops a detailed project, indicating the accessory elements. Prior agreement and when required, assistance in the worksite during the installation, the pouring and the removal stage, is provided.



# EARLY REMOVAL THE SHORING

FORMWORK INSTALLATION: PROPS POSITIONING	10	15	20	25*	30	35	40
A - Distance between the reinforcement beams [A] (cm)	124	124	124	124	63,5	63,5	63,5
B - Distance between the props on Y beams [B] (cm)	200	160	140	130	180	160	140
C - Distance between the props on H beams [C] (cm)	180	180	180	220	180	180	160

FORMWORK REMOVAL: PROPS POSITIONING	10	15	20	25	30	35	40
A - Distance between the reinforcement beams [A] (cm)	-	-	-	-	-	-	-
B - Distance between the props on Y beams [B] (cm)	200	160	140	130	180	160	140
C - Distance between the props on H beams [C] (cm)	360	330	330	280	330	330	280

\* insert the crossbar with crops spaced 220 cdis

NOTE.: concrete temperature 20°, partial removal presumed on the 5th day, presumed crop type B, opening of 300 cm, Q1300 kg

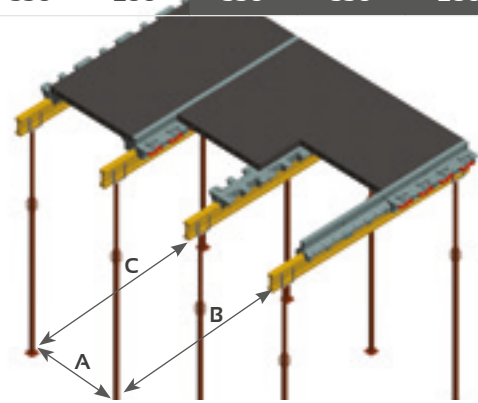

# THE RIGID FORMWORK

REINFORCEMENT - SHORING	10	15	20	25*	30	35	40
A - Distance between the reinforcement beams [A] (cm)	124	124	124	124	63,5	63,5	63,5
B - Distance between the crops on HS beams [B] (cm)	220	180	150	240	210	190	170

REINFORCEMENT - POST SHORING	10	15	20	25	30	35	40
A - Crop disposition [1/m]	5,60	4,60	3,70	3,20	2,80	2,40	2,20

\* insert the crossbar

NOTE.: concrete temperature 20°, partial removal presumed on the 5th day, presumed crop type B, opening of 300 cm, Q1300 kg



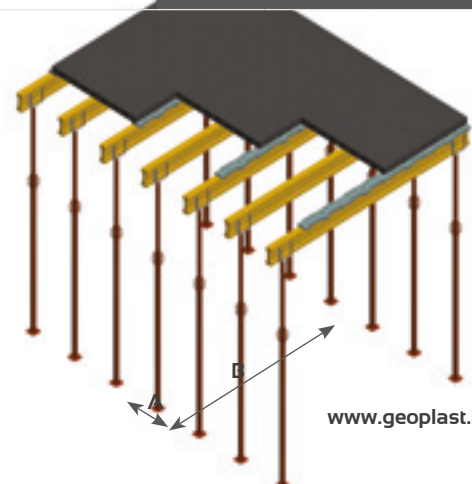

**GEOPLAST S.p.A.**

35010 Grantorto PD - Italia - Via Martiri della Libertà, 6/8

tel +39 049 9490289 - fax +39 049 9494028

e-mail: [geoplast@geoplast.it](mailto:geoplast@geoplast.it) - [www.geoplast.it](http://www.geoplast.it)

